

Article number: 203502803356ST

Description: E+G Levelling sets GN 350.2-80-33-56-ST

Measures

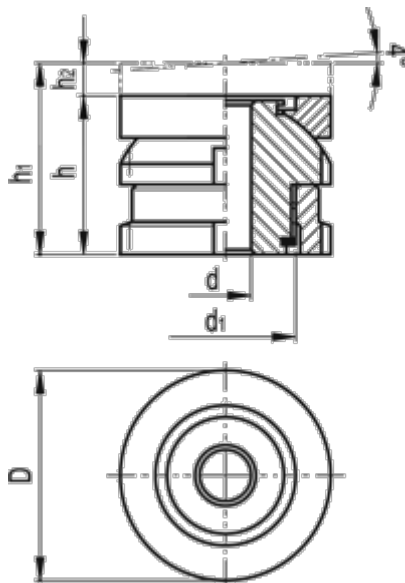

C-spanner DIN 1810 = A80-90

d = 33

D = 80

d1 = M60x2

For screw = M30

h = 56

h1 = 68

h2 = 12

Max static load (kN) = 323

Static preload (kN) = 118.6

Weight (g) = 1000